

series ELYSIUM 3-phase track light LED projector 10 W

ELYSIUM REFLEKTOR LED na szynoprzewody 3-fazowe / LED-Strahler für 3-Phasen-Stromschiene

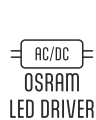

| Colour | Index | EAN | Symbol |
|--------|------------|---------------|---------------------|
| WHITE | 34-0001-10 | 5904405931431 | B-ELYSIUM-10403890W |

| Colour | Index | EAN | Symbol |
|--------|------------|---------------|---------------------|
| BLACK | 34-0002-10 | 5904405932391 | B-ELYSIUM-10403890B |

- > **LUMINES ELYSIUM luminaires** achieve efficacy of up to 130lm/W thanks to the high-quality Bridgelux COB LED and a high-end reflector, providing more light with lower electricity consumption.
- > Thanks to the CRI > 90 they faithfully reproduce colours of the illuminated objects.
- > The aluminium housing effectively dissipates the heat generated by the LED, ensuring a lifespan of 50 000 h.
- > The high-quality OSRAM power supply integrated into the adapter is suitable for three-circuit tracks.
- > 5-year warranty - only carefully selected high-quality components!

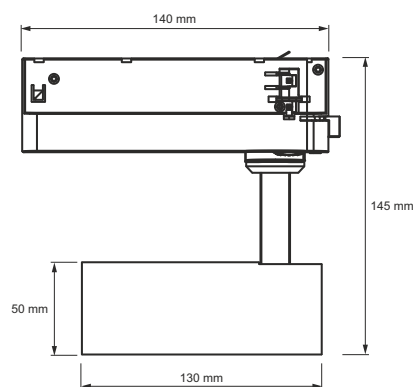

- > **Oprawy oświetleniowe LUMINES ELYSIUM** dzięki zastosowanej wysokiej jakości diodzie LED COB Bridgelux i wysokiej klasy odbłyśnikowi osiągają wydajności nawet do 130lm/W, dzięki czemu zapewniają większą ilość światła przy niższym zużyciu energii elektrycznej.
- > Posiadają CRI > 90 wiernie odwzorowując barwy oświetlanych obiektów.
- > Obudowa wykonana z aluminium skutecznie odprowadza ciepło generowane przez diodę LED zapewniając trwałość na poziomie 50 000 h.
- > Wysokiej jakości markowy zasilacz OSRAM zintegrowany z adapterem dostosowany jest do szynoprzewodów trójfazowych.
- > Zastosowane wysokiej jakości komponenty składają się na produkt o gwarancji 5 lat!

Accessories:
Aksesoria:

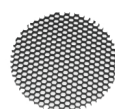

HONEYCOMB
34-0000-11

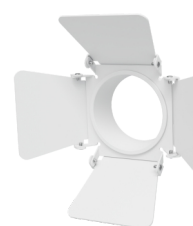

34-0001-11
WHITE



34-0002-11
BLACK

series ELYSIUM 3-phase track light LED projector 10 W

ELYSIUM REFLEKTOR LED na szynoprzewody 3-fazowe / LED-Strahler für 3-Phasen-Stromschiene

3-phase tracklight system
Szynoprzewód trójfazowy

LED COB
Bridgelux

AC/DC
OSRAM
LED DRIVER



FLICKER FREE
BRAK EFEKTU MIGOTANIA

HIGH COLOR RENDERING
INDEX
RA
>90

up to
130
lm/W

SDCM
≤3

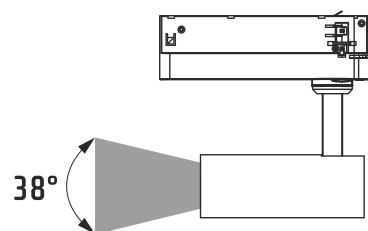
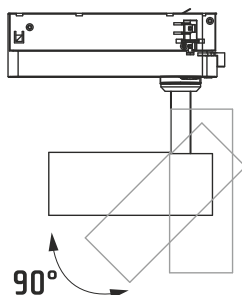
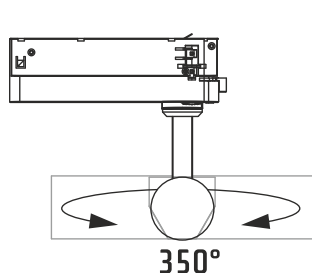
5 YEAR
WARRANTY



> Two axes of rotation, horizontal 350° and vertical 90°, enables a wide range of adjustment of the luminaire.

Dwie osie obrotu, pozioma 350° i pionowa 90° umożliwiają szeroki zakres regulacji oprawy.

> The narrow beam angle of 38° allows the light to be focused only on the illuminated object.

Wąski kąt świecenia 38° pozwala skupić światło na wybranym obiekcie.

TECHNICAL DATA

DANE TECHNICZNE / TECHNISCHE DATEN

| | | | |
|---------------------|----------------|--------------------------|----------------------|
| Input voltage | 220 - 240 V AC | Beam angle | 38° |
| Power | 10 W | Flicker free | SVM ≤1 PstLM ≤0,4 |
| PF | ≥ 0.9 | Ingress protection | IP20 |
| Total main efficacy | 110 lm/W | Working temperature | -20° C +65° C |
| Total luminous flux | 1100 lm | Lumen maintenance factor | 50000 h |
| CCT | 4000 K | On/off cycles | 25000 |
| SDCM | ≤ 3 | Housing material | Aluminium |
| CRI Ra | > 90 | Lens material | PMMA |

Projectors are compatible² with 3-phase tracks from:
Projektorzy są kompatybilne² z szynoprzewodami 3-fazowymi producentów szynoprzewodów:

GLOBAL, UNIPRO, POWERGEAR, STUCCHI

²The compatibility may become invalid when the critical track dimension is modified by the brand owner in case of engineering change or optimization in the future.

³Kompatybilność może stać się nieważna, gdy rozmiar szynoprzewodu zostanie zmodyfikowany przez właściciela marki w przypadku zmiany inżynierskiej lub optymalizacji w przyszłości.

¹This product contains a light source of energy efficiency class E.

⁴Ten produkt zawiera źródło światła o klasie efektywności energetycznej E.

